

INTERIOR DOORS

LET US PERSUADE YOU

The HANÁK motto

“WE BELIEVE THAT QUALITY
IS THE FUTURE OF OUR COMPANY.”



Ing. Stanislav Hanák
Founder

Every part of our interior doors is made with meticulous precision and attention to detail. All of this is reflected in our philosophy of always bringing only the best quality furniture into your home.

Our collection includes LITE, PREMIUM and PREMIUM+ series interior doors for end customers as well as for development projects in the Czech Republic and abroad, where we supply thousands of interior doors. We also manufacture certified fire, hotel and acoustic doors.



HANÁK INTERIOR CONCEPT

We can produce furniture for all of your interior areas of the highest quality with uniform design, material and colour, including the interior doors.



KITCHENS / INTERIOR DOORS / WARDROBES AND CLOSETS / DINING ROOMS
BATHROOMS / BEDROOMS / LIVING ROOMS / CHILDREN'S ROOMS
STUDIES AND HOME OFFICES

THE HIGHEST QUALITY IN THE CZECH MARKET.

VARNISHED DOORS

100% HIGH GLOSS

LUXURIOUS
AND SUPERIOR
DESIGN OF THE
HIGHEST QUALITY

Top-quality polyurethane varnish in high 100% gloss. Very easy maintenance, guaranteed colour stability, UV hardening and a compactly sealed surface.

Why 7 coats of varnish?



Incomparable and inimitable, this is the individually developed finish of our furniture and interior doors. The perfect and hardest surface is achieved **by UV curing lines and the repeated application of thin, interlocking layers of polyurethane varnish**. Applying more layers always results in better compactness and higher durability.



- + 100% gloss level
- + 100% moisture resistant
- + Compact sealed surface – we varnish all sides including joints
- + Surface harmless to health
- + UV curing – high strength and increased scratch resistance



 **30** YEAR
warranty
on varnish quality

 Mendel
 University
 in Brno

THE HIGHEST QUALITY IN THE CZECH MARKET.

VARNISHED DOORS

DEEP MATTE

UNIQUE
HIGHLY DURABLE
VELVETY MATTE
NANO LACQUERS

High-quality lacquer with nano-particles. Fingerprint and scratch resistant. The lacquer is UV hardened with a compactly sealed surface.

Why choose NANO varnishes?

The special application of nano varnishes with UV curing **extends the lifetime and colour fastness** of all of our products. This not only protects your home, but also saves natural resources. The application of these lacquers achieves a velvety matte and unique surface.



- + **Compactly sealed surface**
- + **Surface is harmless to health – we use eco-friendly, water-based varnishes**
- + **UV curing – high strength and increased scratch resistance**
- + 10% gloss level
- + 100% moisture resistance



veneER DOORS

CLEAR VARNISHES

TRANSPARENT
NANO VARNISHES
PROTECT WOOD
IN THE BATHROOM
AND ELSEWHERE

What is the water resistance of transparent varnishes?

Transparent varnishes offer two benefits for your furniture. The first is an aesthetic function, where we use NANO varnishes to enhance the grain and beauty of natural wood. The second benefit is to support the durability and longevity of interior doors. As part of the technological procedures and quality materials used in their production, these varnishes guarantee water resistance and a high-quality surface finish. The veneered doors can even be used in bathrooms or rooms with increased humidity.



- + **Surface is harmless to health**
- + **100% moisture resistant**
- + **Compactly sealed surface**
- + 10% gloss level
- + UV curing – high strength and increased scratch resistance



THE HIGHEST QUALITY IN THE CZECH MARKET.

QUALITY WITHOUT COMPROMISE

WHEN THE ENTIRE OBJECT
IS CREATED WITH DETAIL

By prioritising quality over quantity, we can give each customer special attention to meet their requirements. **All products are equally important to us, so they receive the same manufacturing care** and thus have identical quality characteristics.

Why do we varnish door frames from the underside?

We make sure that every piece of furniture lasts for generations. That's why we place such emphasis on the individual details, which naturally includes painting the door frames on the underside as well. This again demonstrates our uniqueness and focus on places that are no longer visible after installation.



 **30** YEAR
warranty
on varnish quality

 Mendel
University
in Brno

7 COATS OF VARNISH ON THE ENDS OF THE ARCHITRAVE

7 COATS OF VARNISH ON THE TOP EDGE OF THE ARCHITRAVE

7 COATS OF VARNISH IN EACH JOINT

ROBUST STEEL HOLDERS FOR HIDDEN HINGES

- + assembly of the hinges using a metric thread
- + higher resistance to load

R3 RADIUS ON THE DOOR EDGES

- + design matching the architrave
- + elegant rounded elements

5 COATS OF VARNISH ON THE BACK OF THE ARCHITRAVE

- + resistance to residual building moisture

REINFORCING STEEL PROFILE

- + doors without deflection
- + increased door strength

FINAL COATS OF TOP VARNISH ON THE DOOR EDGES

- + ABS edge bonded with SLIM-LINE technology
- + 100% moisture protection

7 COATS OF VARNISH ON THE UNDERSIDE OF THE DOOR

- + high moisture resistance

HIGH-QUALITY SEAL

- + excellent return capability
- + resistant to cleaning agents
- + 100% elastic

7 COATS OF VARNISH ON THE UNDERSIDE OF THE ARCHITRAVE

- + high moisture resistance

THE HIGHEST QUALITY IN THE CZECH MARKET.

PREMIUM SURFACE FINISH

LONG-LASTING AND NATURAL LOOK OF INTERIOR DOORS

In the production of our furniture we only use **pure wood without recycled waste and natural veneers that have passed strict quality control**. The selected collection of veneers and their colours are regularly compiled by our leading designers. In the PREMIUM category, individual staining can also be done according to the client's wishes. All veneers are treated with a final layer of transparent nano varnishes that enhance the wood grain and preserve their **long-lasting and natural appearance**.

How do we protect interior doors and door frames from moisture?

High-quality, transparent NANO varnishes applied by a robotic line with controlled UV curing are the basis for a high-quality surface finish. Of course the underside of the door frame, where the wood is most exposed, is painted. Here we also use a special protective transparent film that additionally seals the wood and prevents moisture from entering the material.



 **30** YEAR
warranty
on varnish quality

 Mendel
University
in Brno

VARNISH ON THE ENDS OF THE ARCHITRAVE

VARNISHING AT EVERY JOINT

VARNISHING OF THE BACK SIDE OF THE ARCHITRAVE

+ resistance to residual building moisture

REINFORCING STEEL PROFILE

+ doors without deflection

+ increased door strength

EDGE MATCHING WITH FRONT FACE

+ perfect transition over the edge

+ vertical and horizontal wood grain

FRAME MATCHING THE FRONT FACE (PREMIUM DOOR INSTALLATION INTO PANELLING)

+ vertical and horizontal wood grain

HIGH-QUALITY SEAL

+ excellent return capability

+ resistant to cleaning agents

+ 100% elastic

VARNISH ON THE UNDERSIDE OF THE DOOR AND ARCHITRAVE

+ high moisture resistance

THE HIGHEST QUALITY IN THE CZECH MARKET.

UNIQUE CONSTRUCTION

DOOR LEAF

ROBUST FRAME AND REINFORCED FINAL FACING

4-times higher resistance of the door leaf against shape deformations. By combining a robust frame made of quality Czech timber and a final door facing **6 mm thick**, we ensure the shape retention and stability of all our interior doors.

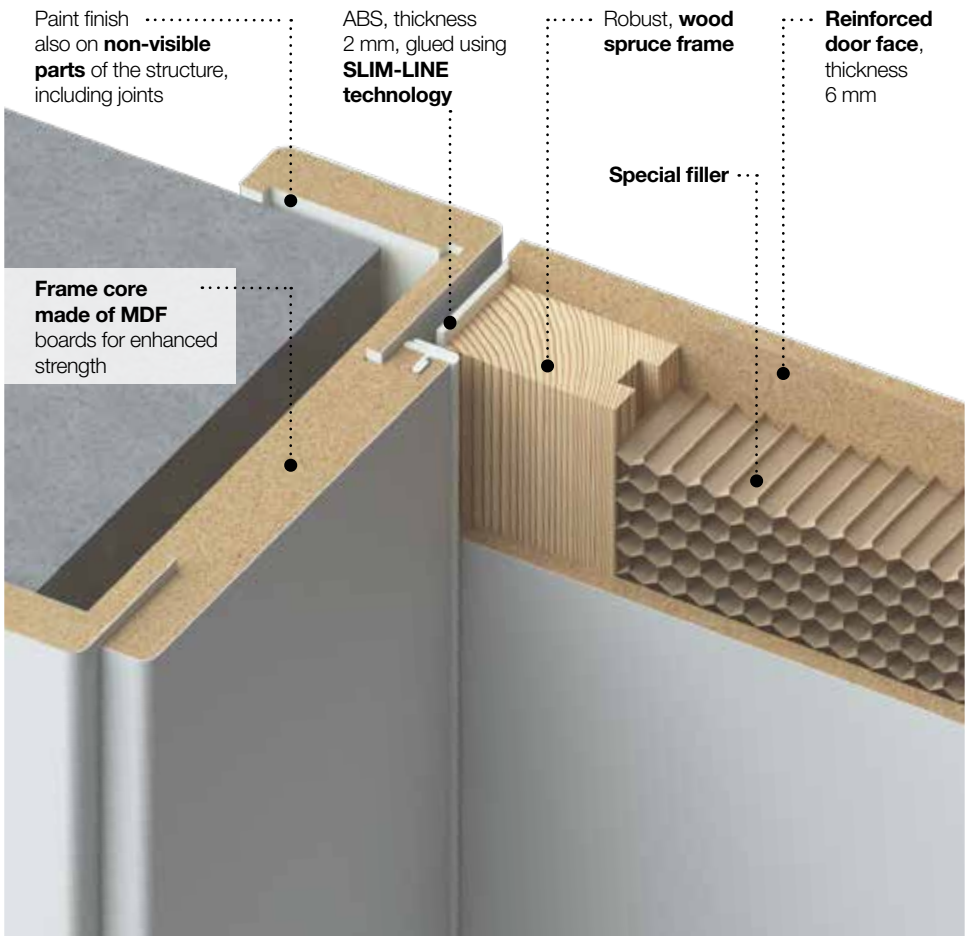

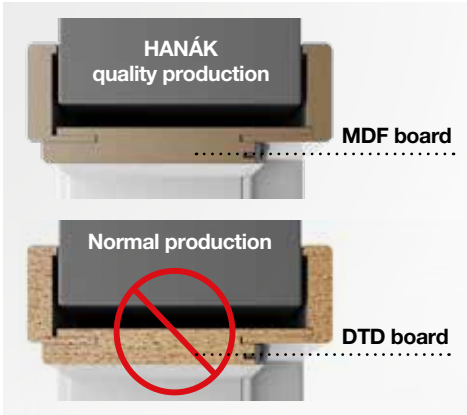

HIGH-QUALITY INPUT MATERIALS

For the production of our interior doors we only use high-quality squared timber and thickened MDF board. **Commonly used chipboard is not suitable for the production of doors and door frames.** We use high-strength PUR adhesives for bonding. The overall construction meets high demands for strength and durability.

STOP POOR QUALITY CHIPBOARD DOOR FRAMES!

REINFORCED DOOR FACE

Unlike conventional doors with 3 mm facing, our interior doors have a thick, 6 mm MDF face. Thanks to its innovative design, we offer increased acoustic resistance even in our basic version. Reinforced facing combined with a robust frame ensures high strength and durability.

STOP WEAK DOOR FACING!

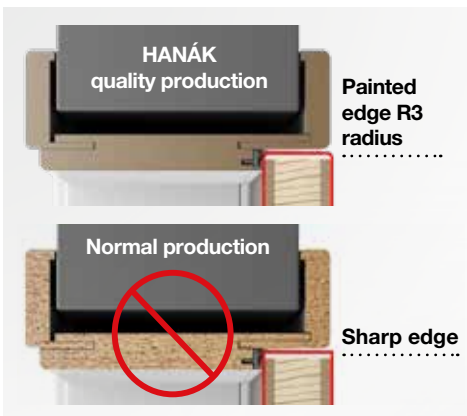
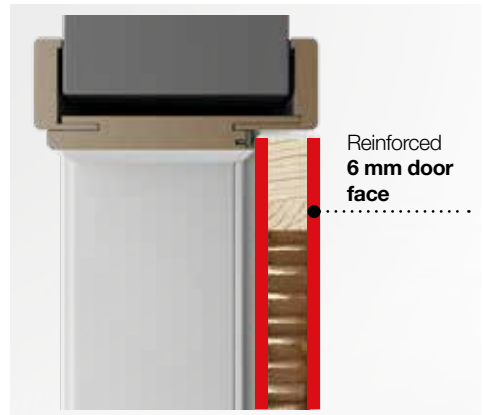

RADIUS ON THE EDGE OF THE DOOR LEAF

Thanks to unique technologies we are able to produce and offer interior doors with a larger R3 radius. Such edge finishing is not only safe for your children's fingers, but also underlines the uniqueness of our interior doors.

STOP SHARP EDGES!

THE HIGHEST QUALITY IN THE CZECH MARKET.

WE PUT QUALITY FIRST

WE REGULARLY TEST THE DURABILITY
OF OUR FURNITURE

In order to provide our customers with **furniture of the highest quality** we continually subject it to rigorous testing, the results of which are a clear **indicator of the quality** of all products.



MECHANICAL RESISTANCE OF DOORS

We test, certify and guarantee the quality of our furniture. We regularly test all our products and always achieve superior results that confirm their quality. This is the only way we can bring **proven furniture** into your home that will serve you well for a long time. All certifications and certificates are available for viewing on our website.

CHECKING THE DEGREE OF GLOSS AND COLOUR SHADE

Our products have been tested by Mendel University in Brno, where they confirmed that **even after 30 years our varnish has almost the same degree of gloss** (0.33% change). The colour was even 100% unchanged. During the production process we constantly check the quality so that the result is always the best.



 **30** YEAR
warranty
on varnish quality

Mendel
University
in Brno



WATER RESISTANCE OF INTERIOR DOORS

All of our furniture parts are carefully varnished and perfectly sealed against atmospheric moisture and high temperatures. This makes it **suitable for rooms with high humidity or different temperatures**, such as bathrooms or garages.

FIRE RESISTANCE OF DOORS

We care about your health and safety, so we have expanded our range of interior doors to include fireproof doors with the necessary certification.

The fire resistance of these doors is up to 30 minutes. You can choose from varnished and veneered versions and achieve a perfect match with the interior furniture or from our range of other interior doors.



ACOUSTIC RESISTANCE OF DOORS

In our assortment of interior doors you will also find acoustic doors with **sound insulation** of 23 dB as a standard. For special doors, you can choose a model with **sound insulation of up to 28 dB**. These doors have also received the necessary certification, just like our fireproof doors

THE HIGHEST QUALITY IN THE CZECH MARKET.

VENEERED DOORS FOR INSTALLATION INTO PANELLING

The high technological and craftsmanship level of our company allows us to make interior doors and panelling into a harmoniously unique whole.

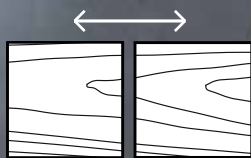

HORIZONTAL
WOOD GRAIN

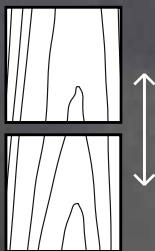

VERTICAL
WOOD GRAIN

VENEERED PANELLING WITHOUT JOINTS UP TO A HEIGHT OF 2,700 mm

VENEERED INTERIOR DOORS

We are one of the few manufacturers who can follow the wood grain of the door leaf, architrave and adjacent panelling. Both vertically and horizontally.

THE WOOD GRAIN
TRANSITIONS SEAMLESSLY
FROM THE DOOR
LEAF TO THE PANELLING

DETAIL
OF WOOD
CONTINUITY



THE HIGHEST QUALITY IN THE CZECH MARKET.

WE HIGHLIGHT THE TRUE **BEAUTY OF WOOD**

WE CAREFULLY
ASSEMBLE EACH PIECE

The result of the entire **veneer treatment process**, from the selection of quality materials through the manufacturing processes to the individual details, such as the orientation of the wood grain and its continuity throughout the interior, is **original and designer furniture**.



HIGH-QUALITY INPUT MATERIALS

We use high quality MDF boards for our products as they have higher strength and moisture resistance compared to the competition. Their density makes them more structurally stable and therefore better suited as a base material for subsequent surface treatment.

ALL PRODUCTION PROCESSES UNDER CONTROL

As we do not use subcontracting and we manage all production processes ourselves in terms of time and materials, we are able to meet all customer requirements. During the production process we constantly check the quality of performed procedures so that the result is always 100%.



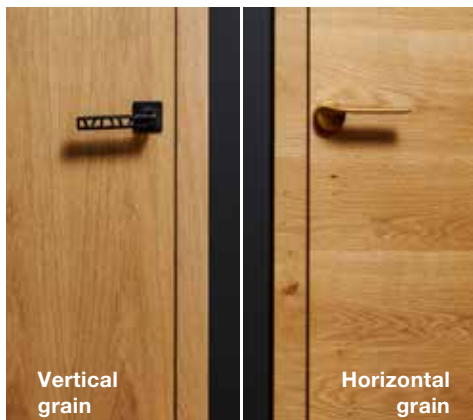

ORIENTATION OF WOOD GRAIN

Every customer will find something for themselves. It's no secret that we are able to customise each product according to the client's wishes. For example, you can choose from vertical or horizontal placement of the veneer, and you can even select the wood grain. We offer American and rustic veneers, including an exotic selection.

INTERCONNECTED VENEER THROUGHOUT THE INTERIOR

The main idea of the HANÁK INTERIOR CONCEPT is to have interiors from one manufacturer, i.e., in a uniform quality and design. This is why we are able to use the same veneer in all rooms of the interior. From furniture, to interior doors, to such detail as the same handle filling.



SPECIALLY STAINED NATURAL VENEERS

Our selected collection of veneers and their colours are regularly compiled by our leading designers. Within the PREMIUM category, **individual staining can also be done according to the client's requirements**. All veneers are treated with a final layer of clear nano varnishes that enhance the wood grain and preserve their **long-lasting and natural appearance**.

THE HIGHEST QUALITY IN THE CZECH MARKET.

VARNISHED DOORS FOR INSTALLATION INTO PANELLING

Thanks to many years of experience, together with a high level of technology and craftsmanship, we can create a unique comprehensive whole from interior doors and panelling.

THE GROOVING TYPE
OF THE INTERIOR DOOR
PERFECTLY FOLLOWS
THE WALL PANELLING

VARNISHED INTERIOR DOORS

Precision in manufacturing is the foundation of success for varnished doors for installation into panelling. We make customised designs for even the most demanding clients in RAL or NCS colours.



VARNISHED PANNELLING WITHOUT JOINTS UP TO A HEIGHT OF 2,700 mm

DETAIL
OF VARNISHED
GROOVES

THE HIGHEST QUALITY IN THE CZECH MARKET.

ELEGANTLY TRANSITIONED VARNISHED PANELLING

PRECISION IS THE BASIS
FOR SUCCESS

Panelling that can blend into the entire interior is a sign of our craftsmanship combined with state-of-the-art **technological processes and perfect painting**. Careful processing and precise installation of panels result in beautiful and luxurious interiors.



ATYPICAL CUSTOMISED GROOVING

Atypical customised grooving represents a combination of precision and individuality. Each design is created with careful attention to uniqueness and quality. We can produce any groove design, for both varnished and veneered models.

HIGH-GLOSS PANELLING

For high-gloss door panelling, we use a special finish that combines aesthetic appeal with high durability. This type of surface is achieved through multi-layer varnishing and the correct base, thus guaranteeing maximum light reflectivity. The result is a smooth and durable surface.





INCORPORATING THE DOOR INTO THE INTERIOR

Matching doors to interiors is a true art, and we can help you achieve this masterpiece. Our doors not only serve to separate spaces; they're also a key design element that shape the look and feel of your home. We pay attention to material, colour and style to achieve harmony with your interior. With our expertise your space will have the unique character and atmosphere you desire.

ELABORATE DETAILS

Elaborate details are often what distinguish good design from excellent design. In the world of design and art, small nuances play an enormous role in the overall result. The design details are therefore not just decoration, but the embodiment of the care, attention and passion put into the furniture.



INFINITE PRODUCTION OPTIONS

Our manufacturing facility boasts endless production possibilities. With state-of-the-art equipment and cutting-edge technology, we can customise a design according to customer requirements. Our experienced team is continuously learning, allowing us to create innovative and quality solutions.

THE HIGHEST QUALITY IN THE CZECH MARKET.

LIST OF MODELS

INTERIOR DOORS



LIST OF MODELS

INTERIOR DOORS



MILLENIUM

MILLENIUM interior doors are one of the most popular doors with our customers. Their exclusivity is given by the highest possible surface finish and minimalist design. They are available in a wide range of colours. These doors are also offered as a glazed variant.



SPACE

A unique natural veneer with a wood structure second to none. This creates the character of SPACE doors, which raise the level of any interior. The range of natural veneers includes various shades of staining from light to darker versions, including staining on request. We also offer these doors in a glazed version.





SPIRIT

If you need to brighten up a space, this can be done with a SPIRIT door. Their individuality is underlined by the frameless fastening system of the glass pane. The application of tempered glass not only provides a load-bearing element, but also pleasant aesthetics.



BOSTON

BOSTON represents an almost fully glazed door variant with a subtle frame. We offer single and double doors with classic opening as well as a sliding variant. This model is the best possible solution above all for entrance areas, where they stand out while accentuating the room's design.



THE HIGHEST QUALITY IN THE CZECH MARKET.

LIST OF MODELS

INTERIOR DOORS



FLY

The all-glass FLY model will allow you to perceive doors in a completely different way. The glass, in combination with an original door frame, suitably complements the glazed door offering. The wide range of glass panels includes clear or tinted versions in several degrees of tinting.



MILANO

A light touch of rusticity in a subtle frame characterises the MILANO door, the subtle design of which is suitable for both modern and rustic interiors. The beautiful design of the handmade patina stands out most in contrasting colours.





VERONA

The VERONA door matches the kitchen model of the same name. A perfect unison of furniture and doors in uniform execution as well as in design. A pronounced element on this door is the decorative ledge and sand blasted motifs in the glass. You can also treat yourself to the same wall panelling to complete the romantic atmosphere.



PARIS

Highly representative PARIS interior doors are absolutely exceptional, especially thanks to the materials used – superior, exotic and root veneers. This classic veneer pattern comes in an interesting contrast, which is refined by state-of-the-art surface treatment with varnishing that makes the doors even more exclusive.



THE HIGHEST QUALITY IN THE CZECH MARKET.

LIST OF MODELS

INTERIOR DOORS



FRAME

Glass door with a cross frame dividing the door leaf into four equal parts. Natural veneers are characteristic for this model. The FRAME model can be glazed or fully veneered. Glass suits these doors nicely, so you can choose both frosted and clear, including shades of grey and bronze.



TWIST

Our pivot door offers a minimalist appearance in a subtle and undisturbed way. This swivel panel with an integrated glass panel in a veneered frame stands out thanks to its formal purity. Variability – these doors are also ideal when used as dividing walls or partitions.





SOLID

Unique and very clean door design with no classic handle and a combination of two materials on the door leaf. Interior furniture in a design of the same name underlines the original look while completing the pure concept of the whole interior.



INDIVIDUAL PRODUCTION

Individual projects using natural veneers, varnishes or special materials and customised design for the implementation of complete interiors.



THE HIGHEST QUALITY IN THE CZECH MARKET.

LIST OF MODELS

INTERIOR DOORS

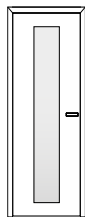

MILLENIUM *

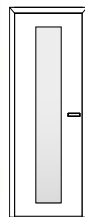

SPACE *

STANDARD HEIGHT (mm)	1,970 – 2,700	1,970 – 2,700
STANDARD WIDTH (mm)	600 / 700 / 800 / 900	600 / 700 / 800 / 900
MATERIAL DESIGN	matte varnish, glossy varnish	matte veneer
GLASS VARIANTS	full, glass without moulding	full, glass in moulding
GLASS COLOURS	clear, satinato, grey clear, grey matte, bronze clear, bronze matte	clear, satinato, grey clear, grey matte, bronze clear, bronze matte
DOOR OPENING SYSTEM	opening, reversing, sliding	opening, reversing, sliding
OTHER OPTIONS	 Fireproofing of doors  Acoustic insulation of doors	 Fireproofing of doors  Acoustic insulation of doors

* SELECTED DOOR TYPES CAN BE AVAILABLE IN BOTH PREMIUM AND LITE MODEL SERIES. **THEY ARE ALSO WELL SUITED FOR DEVELOPMENT PROJECTS OR FLATS INTENDED FOR RENTAL HOUSING.** MORE INFORMATION IS AVAILABLE IN OUR STUDIOS.



SPIRIT *



BOSTON *



FLY

1,970 – 2,700

1,970 – 2,700

1,970 – 2,700

600 / 700 / 800 / 900

600 / 700 / 800 / 900

600 / 700 / 800 / 900

matte varnish, glossy varnish,
matte veneer

matte varnish, glossy varnish,
matte veneer

glass of your choice, matte varnish,
glossy varnish, matte veneer

glazed, glass without moulding

glazed, glass without moulding

all-glass

clear, satinato, grey clear, grey
matte, bronze clear, bronze matte

clear, satinato, grey clear, grey
matte, bronze clear, bronze matte

clear, satinato, grey clear, grey matte,
bronze clear, bronze matte

opening

opening, reversing, sliding

opening, sliding

THE HIGHEST QUALITY IN THE CZECH MARKET.

LIST OF MODELS

INTERIOR DOORS

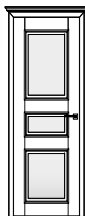
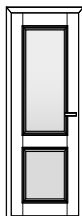

MILANO

VERONA

PARIS

1,970 – 2,700

1,970 – 2,700

1,970 – 2,700

600 / 700 / 800 / 900

600 / 700 / 800 / 900

600 / 700 / 800 / 900

matte varnish with patina
/ without patina

matte varnish, glossy varnish

glossy veneer

full, glass in moulding

full, glass in moulding

full

clear, satinato, grey clear, grey
matte, bronze clear, bronze matte,
sandblasted motif

clear, satinato, grey clear, grey
matte, bronze clear, bronze matte,
sandblasted motif

opening, reversing, sliding

opening, reversing, sliding

opening, reversing, sliding



Fireproofing of doors



Acoustic insulation of doors



FRAME

TWIST

SOLID

1,970 – 2,500

1,900 – 2,500

1,970 – 2,700

600 / 700 / 800 / 900

600 – 1250

600 / 700 / 800 / 900

matte veneer

veneer and glass combination
of your choice

combination of veneer and mate
varnish, glossy varnish

full, glass without moulding

glazed

full

clear, grey clear, bronze clear

opaque lacobel glass – black,
white

opening, sliding

swinging

opening

THE HIGHEST QUALITY IN THE CZECH MARKET.

OVERVIEW OF OPTIONS

OPENING



OPENING DOORS,
SINGLE-LEAF
AND DOUBLE-LEAF

REVERSE
OPENING

SLIDING
INTO HOUSING,
SINGLE-LEAF
AND DOUBLE-
-LEAF



**SLIDING
IN MOULDING
SINGLE-LEAF
AND DOUBLE-LEAF**



**SLIDING,
SINGLE-LEAF
AND DOUBLE-LEAF**



**SWINGING
DOORS**

THE HIGHEST QUALITY IN THE CZECH MARKET.

WHAT IS AT THE CORE OF **OUR COMPANY PRIDE?**

WE PROVE OUR QUALITY
WITH OUR ACTIONS

The three key points that reflect our company's philosophy are **quality, tradition and innovation**. Each piece of furniture reflects our craftsmanship, love of wood and attention to detail. We believe in combining traditional practices with modern trends to give our customers furniture that will last for generations.



CZECH PRODUCTION WITH A TRADITION

We are a purely **Czech family business with a long tradition**. Our experience and knowledge in furniture and varnishing is **unmatched**. Craft and **know-how** are handed down from generation to generation, so the secret of our unique quality is preserved.

HARMLESS TO HEALTH

We care about nature. We produce furniture that is made to last **decades** and that will serve you and your future generations. We prevent the leakage of residual formaldehyde by taping all furniture edges, even the non-visible parts, using patented SLIM-LINE technology. Many healthcare facilities have been equipped with our furniture.





5-YEAR WARRANTY

We are a reliable partner for your projects.

We are one of the few manufacturers to offer an extended **5-year** warranty on interior doors and door frames. Selected input materials and technological procedures allow us to guarantee the high quality and durability of all our doors.

OPTIONAL DIMENSIONS AND COLOURS

The LITE range of interior doors offers a selected collection of colours, materials and sizes, while the PREMIUM range of interior doors extends the collection with a range of additional colours and natural veneers, including atypical sizes and doors for installation into panelling. The height of a door may reach up to 2,700 mm. Matching materials and colours with other interior furniture of our brand come naturally with us.



Doors are up to 2,700 mm high



MORE THAN 60 SHOWROOMS

We strive to be ever closer to our customers, and we care deeply about their experience in our showrooms. We have sales offices throughout the Czech and Slovak republics, Europe and the United States.

THE HIGHEST QUALITY IN THE CZECH MARKET.

WHAT IS IMPORTANT TO GET THE **RIGHT RESULT?**

PRECISE SURVEYING & MEASURING OF INTERIOR DOORS

Below you will find detailed instructions on how to **properly survey and measure the space** for the interior door and the individual specifications.

STANDARD OPENING LEFT

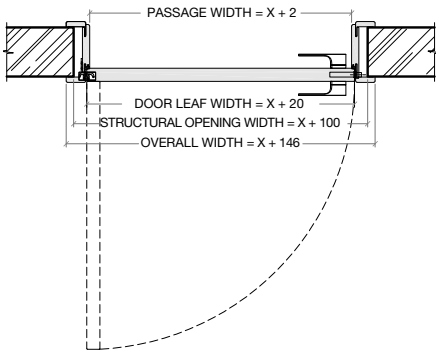

STANDARD OPENING RIGHT

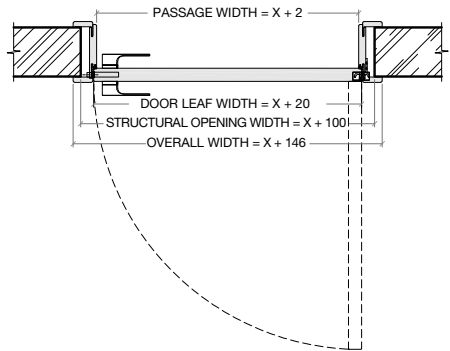

INTERIOR DOORS WITH HIDDEN DOOR FRAME (LEFT)

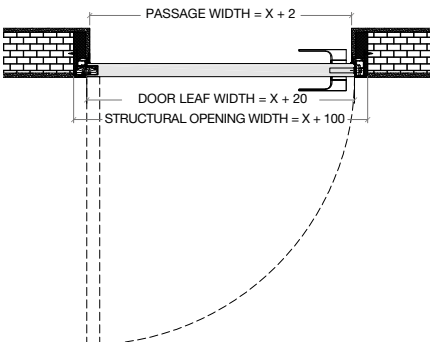

REVERSE OPENING (RIGHT)

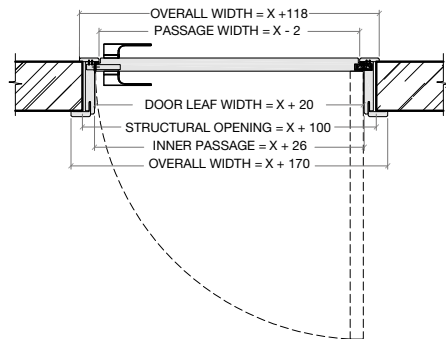

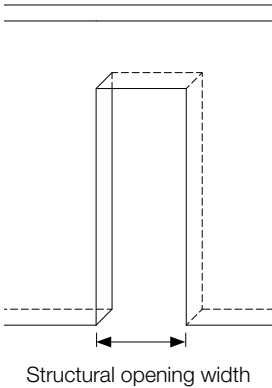

WIDTH	CLEARANCE	RECOMMENDED CONSTRUCTION OPENING
OPENING DOORS SINGLE-LEAF DOORS STANDARD + REVERSING	600	700
	700	800
	800	900
	900	1,000
OPENING DOORS DOUBLE-LEAF DOORS STANDARD	1,200	1,300
	1,300	1,400
	1,400	1,500
	1,500	1,600
	1,600	1,700
	1,700	1,800
	1,800	1,900

* Width tolerance of structural opening of opening doors = +/-20 mm

** Width tolerance of structural opening of reversing doors = + 10 mm/-5 mm

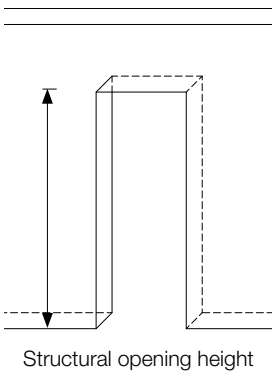

HEIGHT	CLEARANCE	RECOMMENDED CONSTRUCTION OPENING
OPENING SINGLE-LEAF STANDARD DOOR + REVERSING + DOUBLE-LEAF DOORS	1,970	2,020
	2,100	2,150
	2,200	2,250
	2,300	2,350
	2,400	2,450
	2,500	2,550
	2,600	2,650
	2,700	2,750

* Height tolerance of structural opening of opening doors = +/-15 mm

** Height tolerance of structural opening of reversing doors = +/-5 mm

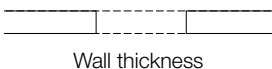

The thickness of the walls can be 80-500 mm.
Door frames are manufactured in 10 mm increments.

* Tolerance of structural opening of opening/reversing doors = 0 mm /+15 mm

THE HIGHEST QUALITY IN THE CZECH MARKET.

WHY INVEST IN **QUALITY**?

WE DO NOT WORK WITH CPL FOILS

At HANÁK NÁBYTEK we produce varnished and veneered interior doors, which have a much **greater durability and longer overall life**. We deliberately do not work with CPL films, which did not reach such quality after many tests.



VARNISHED INTERIOR DOORS

For processing we prefer varnishing, which not only offers the highest quality but also the possibility to choose from a wide range of colours. We also offer the advantage of high durability and health safety of surfaces.

VENEERED INTERIOR DOORS

The greatest advantage of this type is the natural, timeless design, guaranteeing a tasteful and modern interior. Sustainable production methods are also reflected in the final product. Each piece of furniture is a unique piece which, thanks to its natural appearance, is never repeated.



HANÁK DOOR

 **30** YEAR
warranty
on varnish quality

- ✓ More durable surface without susceptibility to damage
- ✓ Natural appearance and high-quality materials
- ✓ Water resistance of interior doors
- ✓ Greater choice of materials and wide range of colours
- ✓ Resistance of varnishes to sunlight and other influences
- ✓ Surface is easier to repair
- ✓ Uniform appearance in harmony with the entire interior and minimalist design
- ✓ Protection against deformation and thermal influences
- ✓ Varnished doors add a modern touch to the interior
- ✓ Varnishes can be customised to specific requirements
- ✓ Resistant to chemicals
- ✓ Harmless to health
- ✓ Longevity = economic and ecological

DISADVANTAGES OF DOORS WITH CPL FOIL

- ✗ Low resistance and surface sensitivity
- ✗ Door colour change after years
- ✗ Shorter door lifetime
- ✗ Limited choice of colours and décors
- ✗ Low gloss
- ✗ Doors are not completely protected from moisture
- ✗ Visible joints
- ✗ Inconsistent appearance with other furniture in the interior
- ✗ Susceptibility of doors to temperature changes

REALISED PROJECTS

WE HAVE REALISED **THOUSANDS**
OF INTERIOR DESIGN PROJECTS,
SINGLE-FAMILY HOUSES AND FLATS







LUXURY

The interior of a single-family house is a combination of natural materials. SPACE interior doors are very tastefully and precisely processed with the veneer following the panelling. The whole interior is in a natural spirit with designer elements.

THE HIGHEST QUALITY IN THE CZECH MARKET.



The panelling, which not only runs along the entire corridor but also connects to the kitchen, is a sign of our craft experience combined with the latest technological procedures. Careful processing and installation of panelling result in beautiful and luxurious interiors.







PURITY

Designer execution of the interior in a new single-family house. The combination of natural veneer and high-gloss varnish is reflected throughout the entire interior, including the MILLENIUM interior doors.

THE HIGHEST QUALITY IN THE CZECH MARKET.



The entire realisation, like all realised projects, is the result of precision and many years of experience in the production of furniture and doors, hand in hand with the latest technological procedures.



REALISED PROJECTS

**WE ARE RELIABLE PARTNERS
IN SUCCESSFUL DEVELOPMENT PROJECTS
FOR RESIDENTIAL AND RENTAL HOUSING**



Henceforth.



MARINA ISLAND



1,730 Interior doors

CHATEAU TROJA RESIDENCE



350 Interior doors

MARINA NOVA



660 Interior doors

VICTORIA PALACE



450 Interior doors

V-TOWER PRAGUE



60 Complete interiors

REZIDENCE ŠÁRECKÝ DVŮR



270 Interior doors

THE BERKELEY LONDON UK



322 Fireproof doors

ALMANAC VIENNA AUSTRIA



128 Fireproof doors

THE MAYBOURNE RIVIERA MONACO



154 Fireproof doors

INSTALLION BY **PROFESSIONALS**

THE INSTALLATION OF HANÁK
INTERIOR DOORS IS EASY,
FAST AND HIGH QUALITY

If you decide to realise your project, **we will arrange the complete service from surveying and measuring to placement** including the installation of hinges and handles. As part of the professional attachment, careful preparation for the mounting foam also takes place, including the installation of the target architrave.





Unpacking and preparation



Fitting the door frame



Completing the door frame



Fitting the door frame



Installation of the hinges



Installation of the handle



Preparation for mounting foam



Anchoring with mounting foam



Installation of the target architrave

MADE IN CZECH REPUBLIC **STATE-OF-THE-ART** **MANUFACTURING PLANT**

INSURMOUNTABLE TECHNOLOGICAL LEAD

Comprehensive and one of the **most modern manufacturing plants** for the manufacture of furniture and interior doors in Europe. The area of the production premises is 69,500 m².





VARNISHING **STATE-OF-THE-ART TECHNOLOGY**

OVER 30 YEARS
OF VARNISHING EXPERIENCE

The varnishing **technologies used** in the 7,000 m² shops match the standard of world-class production plants. By combining many years of experience and continuous investment in development, we always achieve the **best results**.





HIGHEST QUALITY INTERIOR DOORS

WE USE THE LATEST TECHNOLOGY
FOR THE PRODUCTION
OF INTERIOR DOORS

The craftsmanship of the door frames and maximum durability of the door leaf construction, combined with a luxurious finish, make our doors unique in the market. The high-quality workmanship meets with the idea behind the HANÁK INTERIOR CONCEPT, i.e., connecting the materials and design of the entire interior.





SALES OFFICES

MORE THAN
60 SHOWROOMS
WORLDWIDE

USA New York / Miami / Florida / Seattle / Charlotte

UK Newport / Suffolk / Chelmsford / South Benfleet / Canterbury

Austria Vienna

Belgium Houtvenne

Lithuania Kaunas

Hungary Szekszárd

Bulgaria Sofia

Kazakhstan Almaty / Astana

Slovak Republic Bratislava / Zvolen / Košice / Žilina

Czech Republic Praha / Brno / Popůvky u Kojetína / České Budějovice /
Hradec Králové / Plzeň / Zlín / Kladno / Ostrava / Jihlava / Liberec /
Olomouc / Ústí nad Labem / Pardubice / Kolín / Mladá Boleslav /
Lovosice / Most / Hodonín / Prostějov / Vsetín / Šumperk

© 2023, HANÁK NÁBYTEK, a.s.

All rights reserved. HANÁK NÁBYTEK, a.s. reserves the right to change this information without prior notice.
The colours presented in the pictures do not necessarily correspond with the actual shades.

Made in Czech Republic

 **HANÁK** | Interior Concept

HANÁK NÁBYTEK, a.s. | Komenského náměstí 363/8, 767 01 Kroměříž
Company ID No.: 26231573 incorporated in the Commercial Register
maintained by the Regional Court in Brno, File ref. No. B / 3485

www.hanak-nabytek.cz